

**ACCENTS**

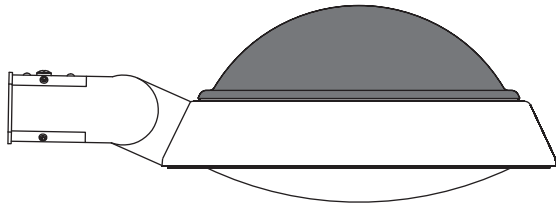

**AD Colored Dome (HORIZON series)**

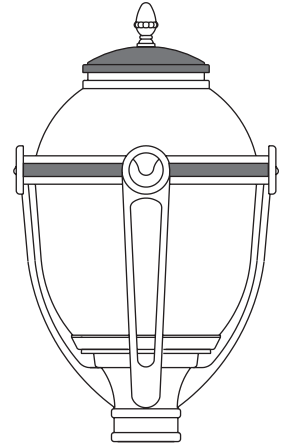
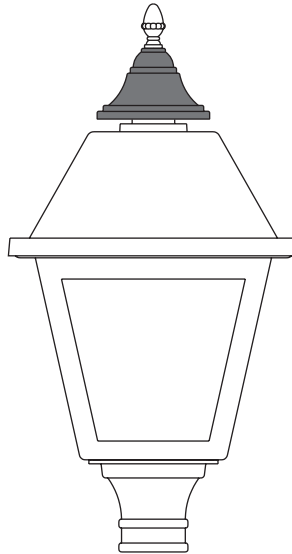

- AC** Copper Accent
- AB** Brass Accent
- AO** Chrome Accent

**EXAMPLE**

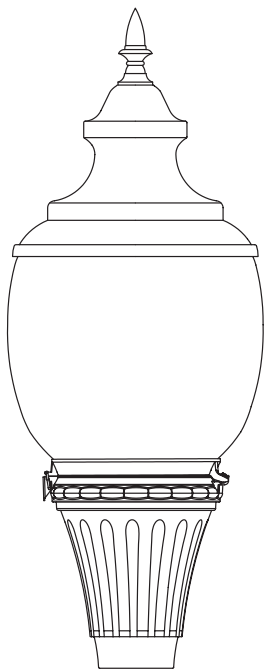

**PRO 101 with PA2H & F3 options**

**FINIALS**

3"



**F1**

2.5"



**F2**

4"



**F3**

6"



**F4**

7"

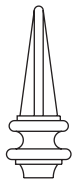

**F5**

**POLE ADAPTORS**

Tenon adaptor Ø4"x3"long

Option PTR3 Tenon adaptor Ø3"x3"long

7"

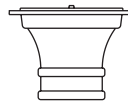

**PA1**

9"

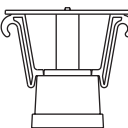

**PA3**

12"

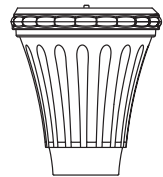

**PA2H**

12"

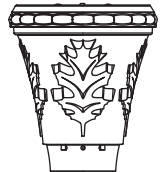

**PA4H**



**Quattro**

Lighting

www.quattrolighting.com

# Option Guide

## ELECTRICAL OPTIONS

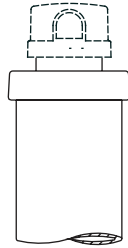

**PTL** Twist-lock Photocell receptacle, multi-directional.

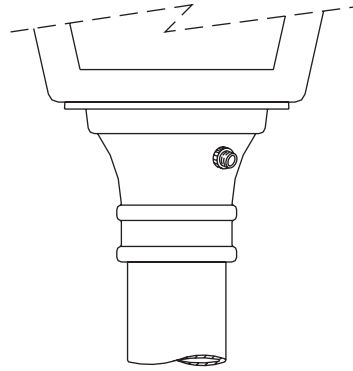

**FITTER**

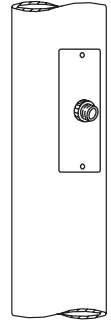

**POLE**

**PBT** Button Type Photocell

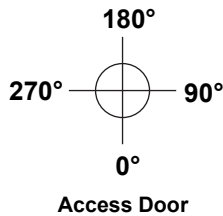

**Access Door**

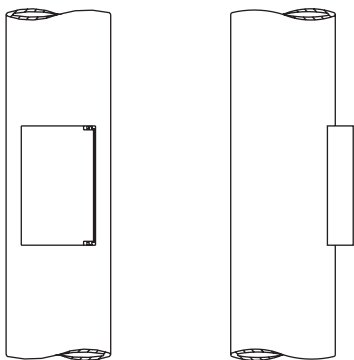

**DR** Duplex Receptacle \*

**GFI** Duplex Receptacle with Ground Fault Interrupter \*

\* C/w weatherproof cover

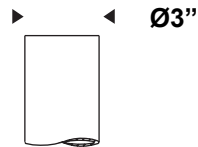
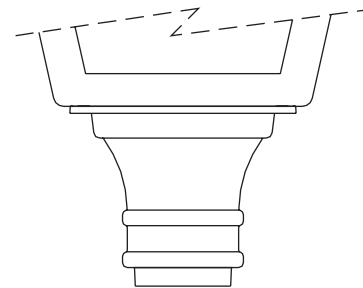

**PTR3** Post Top Reducer Ø3"

**LF1** SINGLE In-Line Fusing

**LF2** DOUBLE In-Line Fusing

**LADDER REST (decorative)**

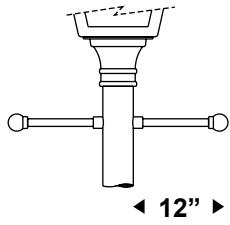

LRM/F2

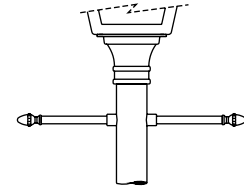

LRM/F1

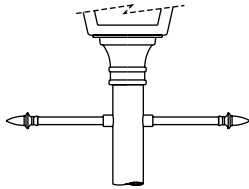

LRM/F3

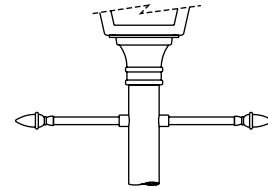

LRM/F4

**BANNER ARMS & PLANT HOLDER**

**SLEAVE**

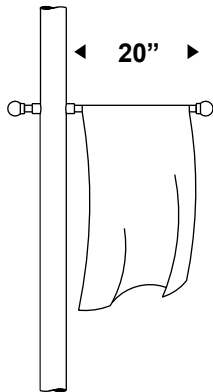

BRM/S  
BRK/S (BREAK-AWAY)

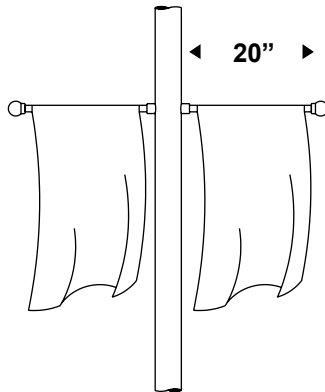

BRM/ST  
BRK/ST (BREAK-AWAY)

**PLANT HOLDER**

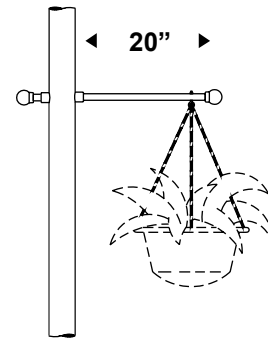

PLH/S (SIMPLE)  
PLH/D (DOUBLE)

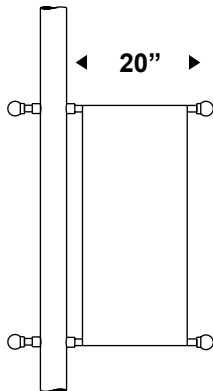

BRM/D  
BRK/D (BREAK-AWAY)

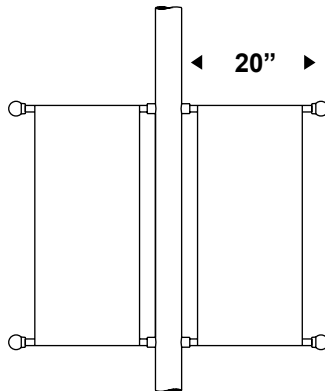

BRM/DT  
BRK/DT (BREAK-AWAY)

**CLAMPS (AJUSTABLE)**

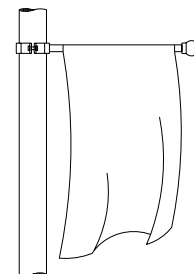

CRM/S  
CRM/ST  
CRM/D  
CRM/DT