

Ordering #

Wall thickness

# STFP64 J

0.1196" (11 Ga)

# STFP64 K

0.1793" ( 7 Ga)

## Pole Guide

Round  
Tapered  
Fluted  
Steel

# STFP64

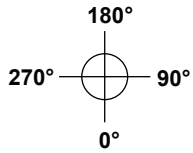

### AVAILABLE FLUTED SHAPES

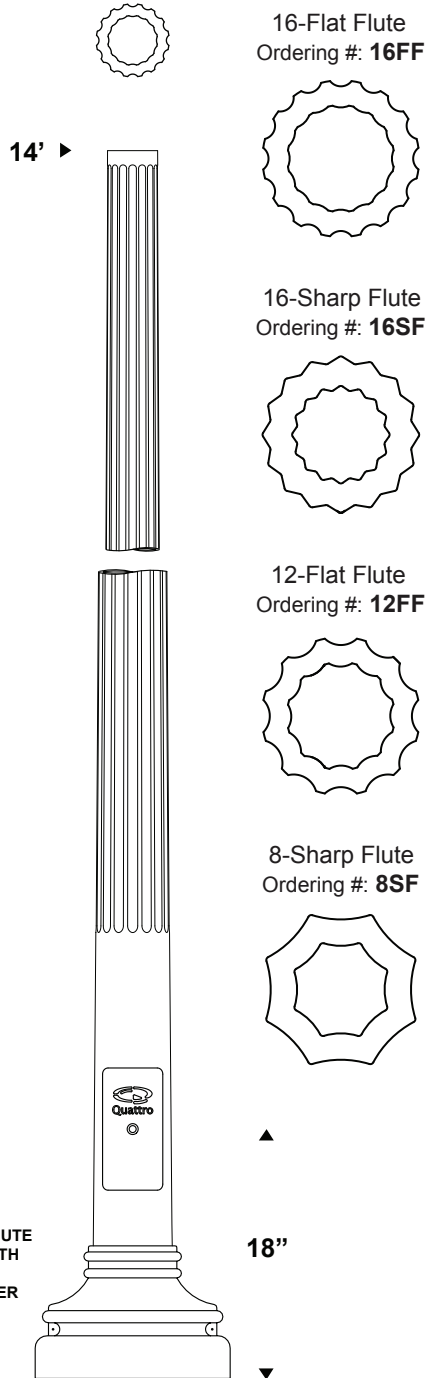

16-FLAT FLUTE SHOWN WITH #BQ311 BASE COVER

16-Flat Flute  
Ordering #: **16FF**

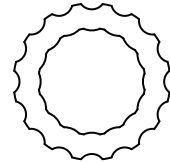

16-Sharp Flute  
Ordering #: **16SF**

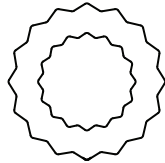

12-Flat Flute  
Ordering #: **12FF**

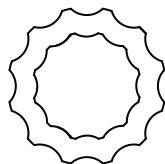

8-Sharp Flute  
Ordering #: **8SF**

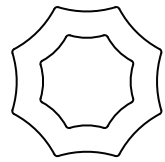

### ORDERING INFO

POLE	HEIGHT	BASE COVER	COLOR	OPTION
STFP64J / 16FF	14	BQ340A	BKTX	GFI

Round tapered fluted steel pole made from a ASTM A595 Grade-A conical fluted tube. Base is welded to a steel anchor plate. A 4" by 9" hand hole is located at 18" from anchor plate c/w ground bolt. Cast aluminum door provided with weatherproof gasket and hex socket head cap screw.

Dimensions can vary: Contact Quattro technical sales representative for available bottom and top diameters and heights.

### ANCHOR PLATE DETAIL

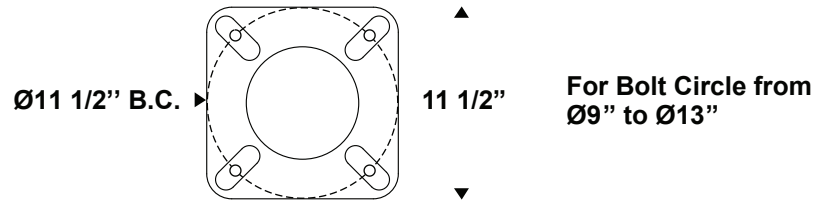

### INSTALLATION DETAIL

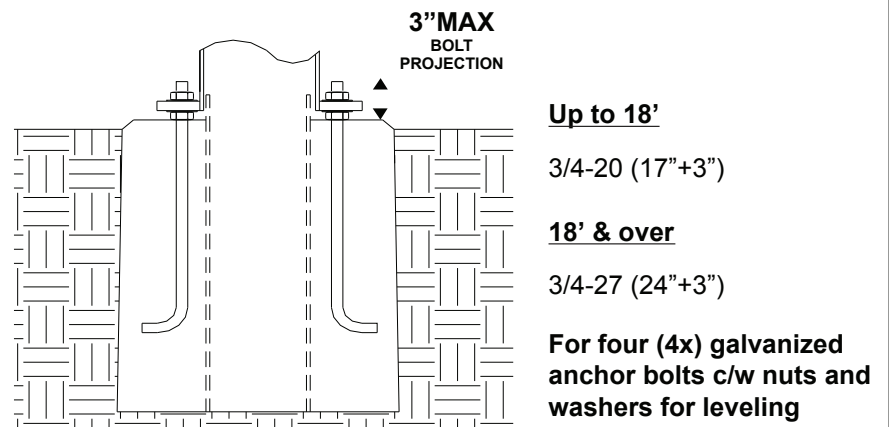

### OPTIONS

<b>LF1</b> Single In-Line Fusing	<b>GALV</b> Galvanized	<b>TP</b> Tamper Proof Screw (Access Door)
<b>LF2</b> Double In-Line Fusing	<b>PBT</b> Button Type Photocell	<b>PTL</b> Twist Lock Photocell Receptacle
<b>DR</b> Duplex Receptacle c/w Cover	<b>PTL1</b> Twist Lock Photocell Receptacle c/w Painted Photocell Cover	
<b>GFI</b> Duplex Receptacle c/w Ground Fault Interrupter and Cover		

### COLOR

Consult color chart

**QUATTRO**  
www.quattrolighting.com